

Part No. FD9660
 ETD 44/22/15 Vertical Bobbin

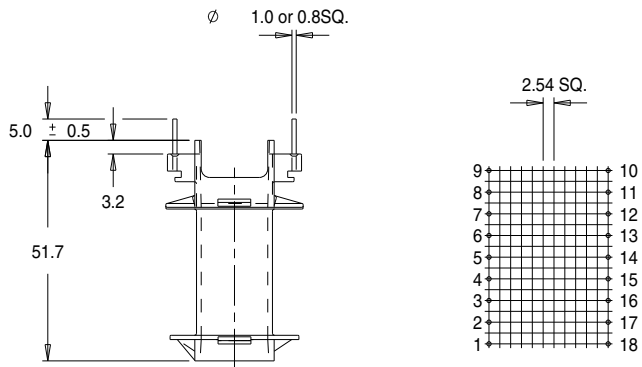

Dimensions in millimetres.

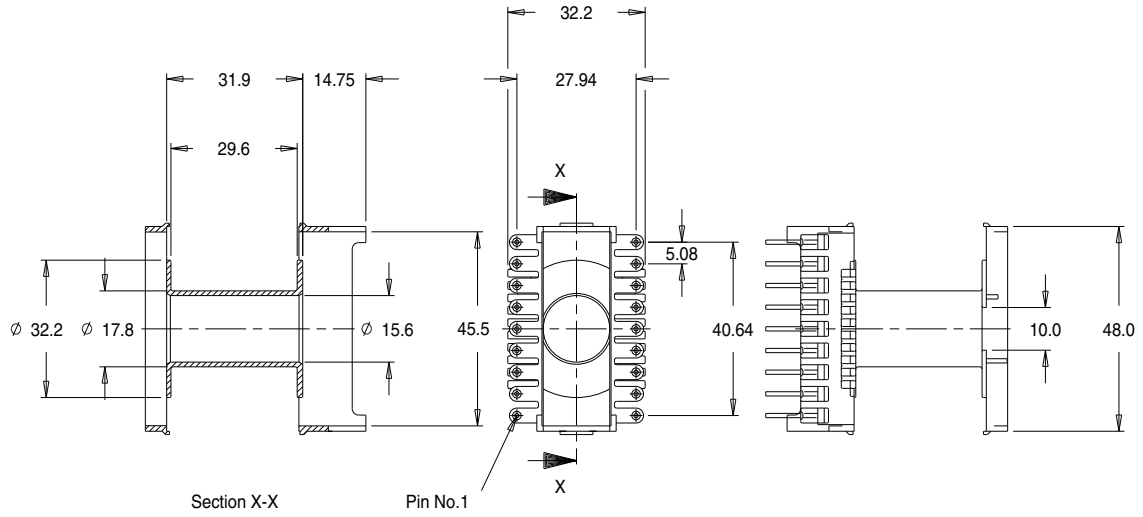